

Socket for DOLD Safety relays

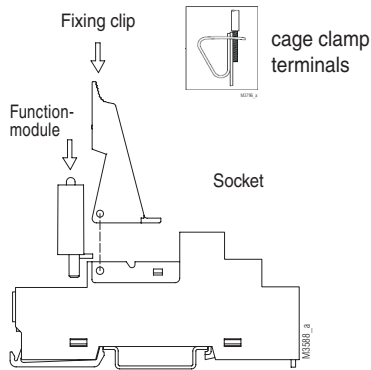

OA/OW 5668, OA/OW 5669, OA 5672, OA 5682, OB 5694



ET 1415.047

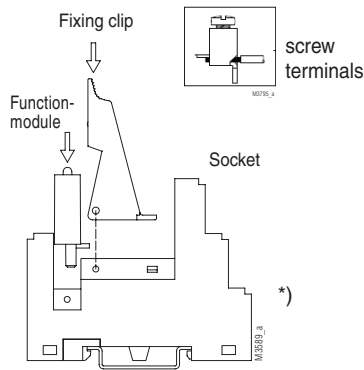

ET 1415.044
safety separation between relay coil and contact

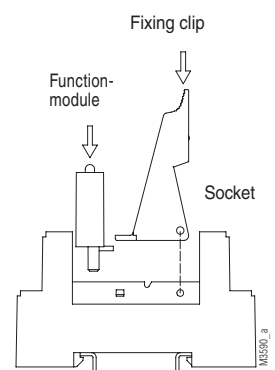

ET 1415.041

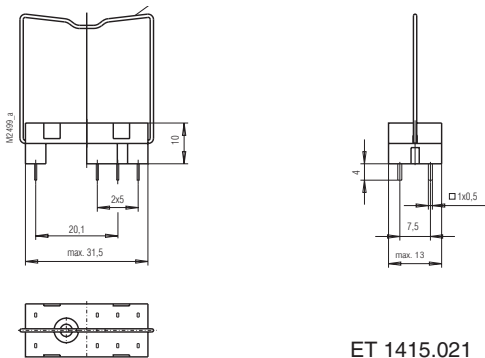

ET 1415.021

Terminal designation

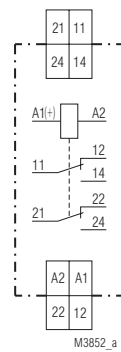

ET 1415.041

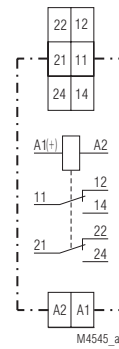

ET 1415.044
ET 1415.047

OA 5670

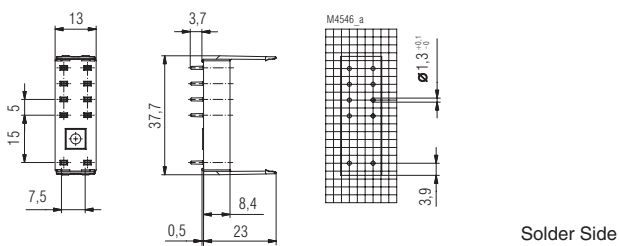

Solder Side

OA 5601

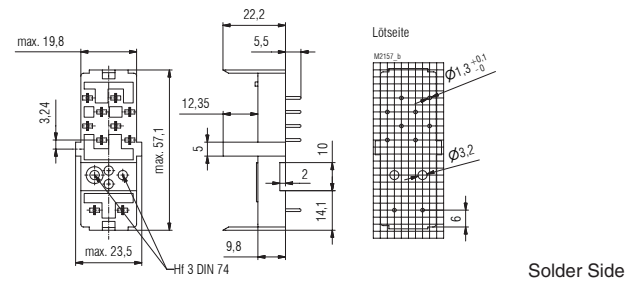

Solder Side

OA 5602

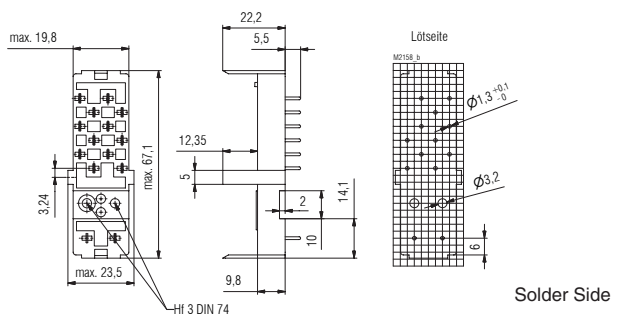

Solder Side

OA 5603

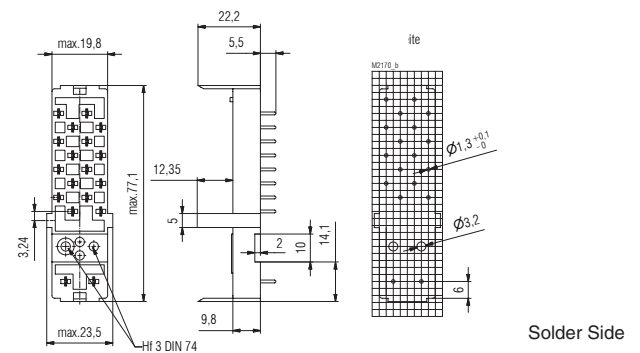

Solder Side

Socket for DOLD Safety relays



OA 5611

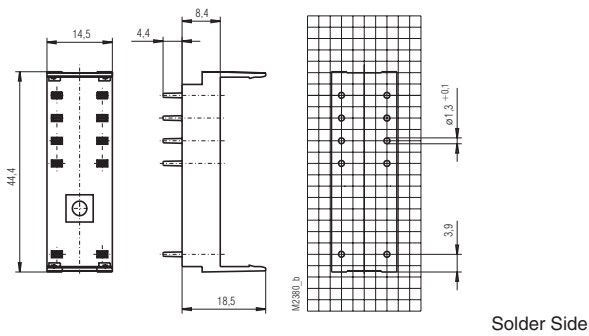

OA 5612

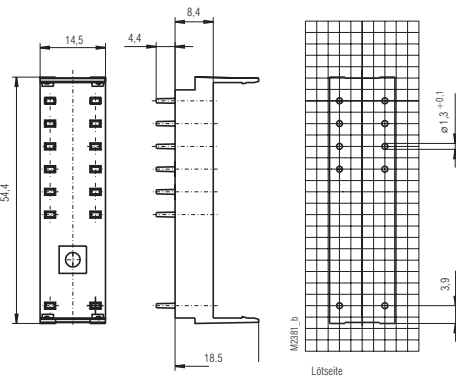

OA 5621

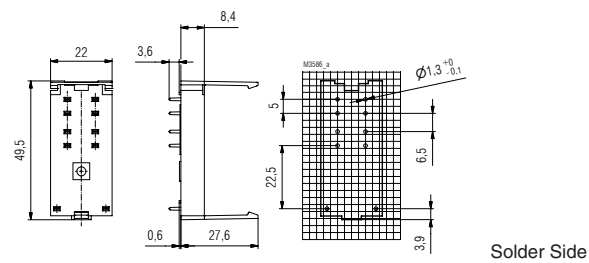

OA 5622

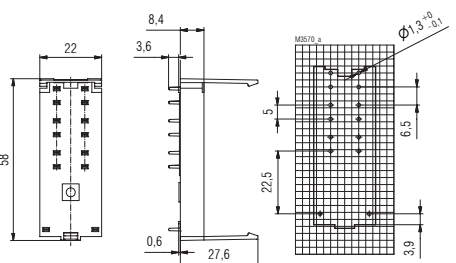

Order references

Relay type	Socket	Fixing clip	Function modul
OA/OW 5668, OA/OW 5669 OA 5672, OA 5682 OB 5694	ET 1415.021 ET 1415.044 ET 1415.047 ET 1415.041	ET 1415.025 included included included	ET 1415.913 (DC, with free-wheeling diode and green LED) ET 1415.911 (DC, with free-wheeling diode and red LED) or ET 1415.912 (AC/DC, with green LED)
OA 5601	ET 1415.011	-	
OA 5602	ET 1415.012	-	
OA 5603	ET 1415.013	-	
OA 5611	ET 1415.031	-	
OA 5612	ET 1415.032	-	
OA 5621	ET 1415.035	-	
OA 5622	ET 1415.037	-	
OA 5670	ET 1415.034	-	